

1 ISOMETRIC VIEW
Scale: NTS

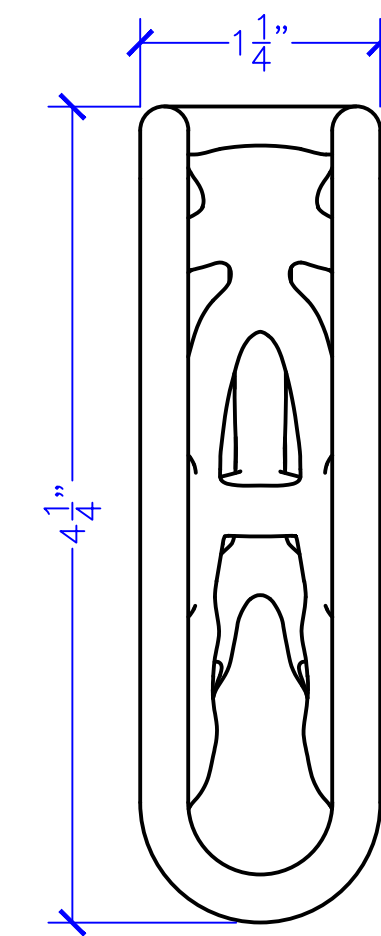

3 TOP VIEW
Scale: 1" = 1"

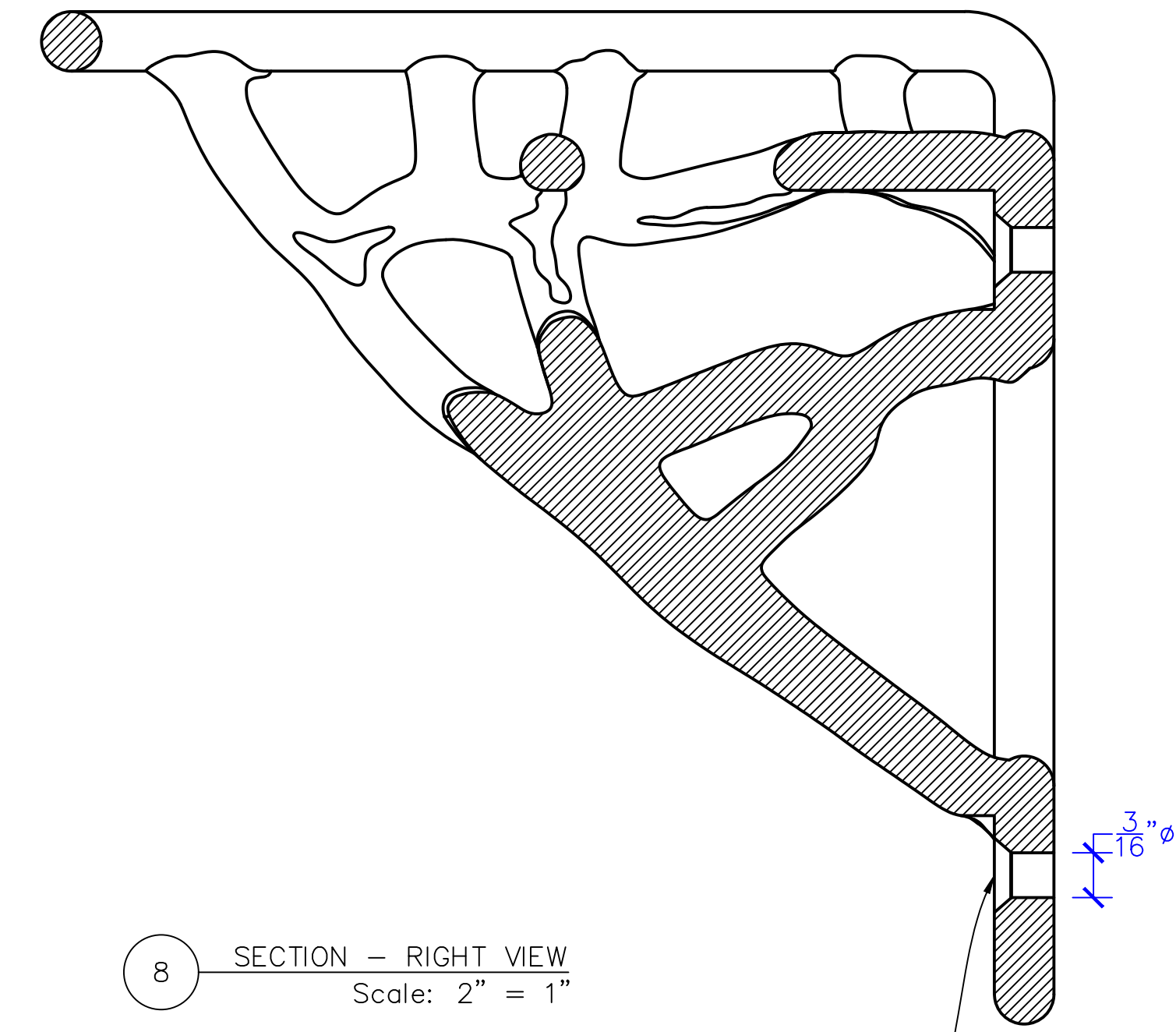

8 SECTION - RIGHT VIEW
Scale: 2" = 1"

COUNTERSUNK FOR H-1

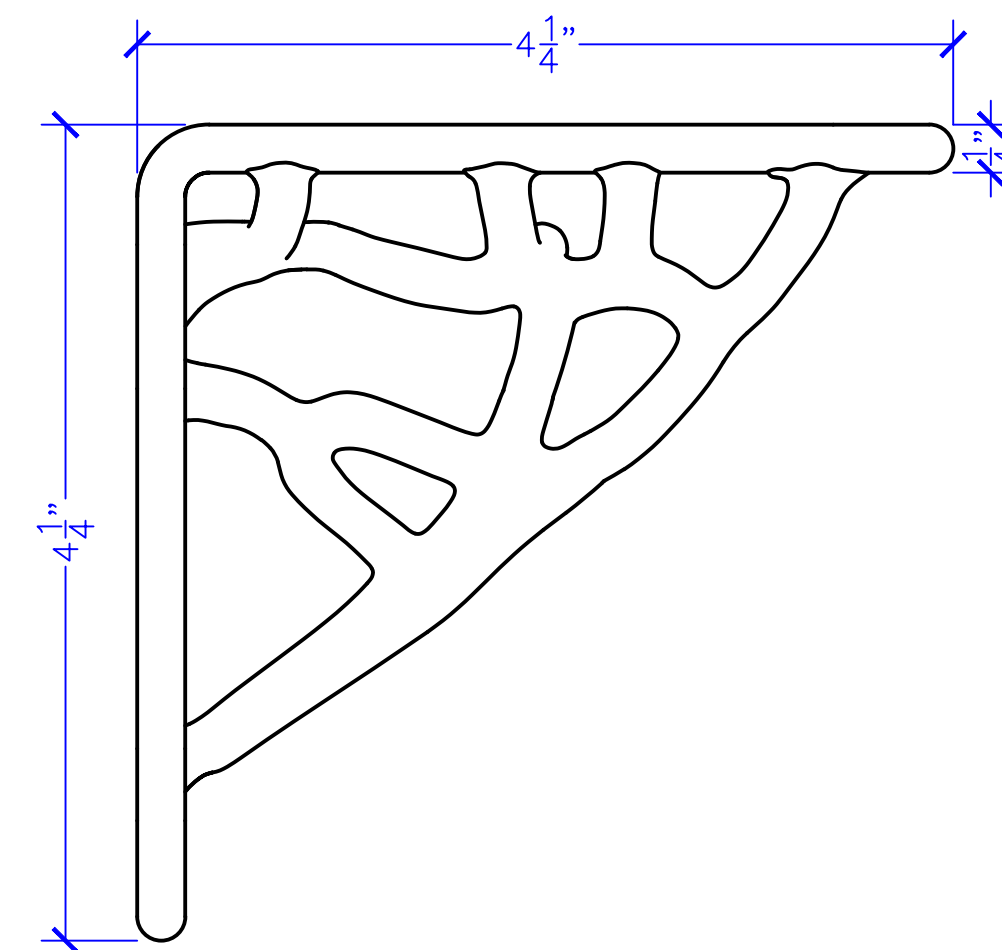

4 LEFT VIEW
Scale: 1" = 1"

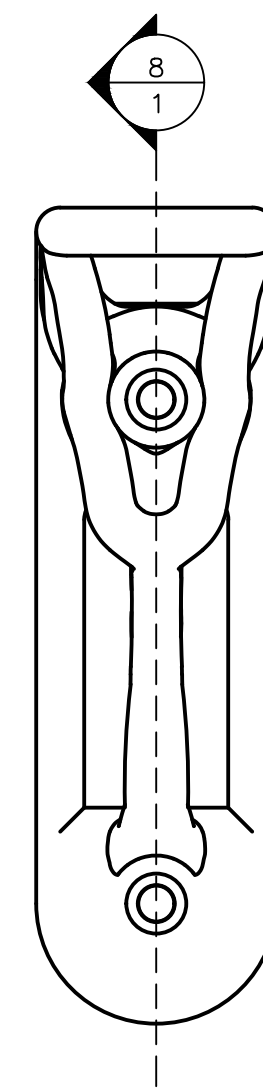

5 FRONT VIEW
Scale: 1" = 1"

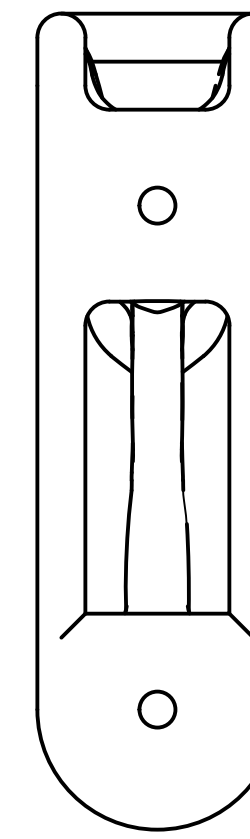

6 BACK VIEW
Scale: 1" = 1"

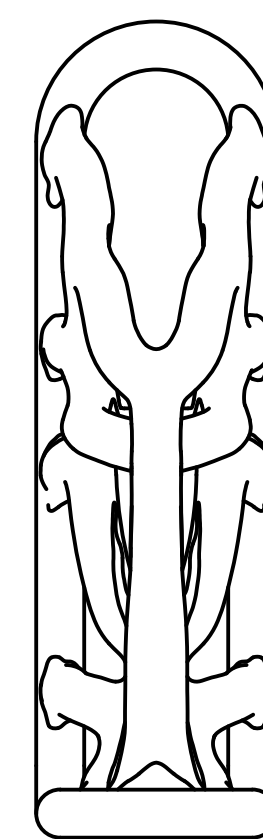

7 BOTTOM VIEW
Scale: 1" = 1"

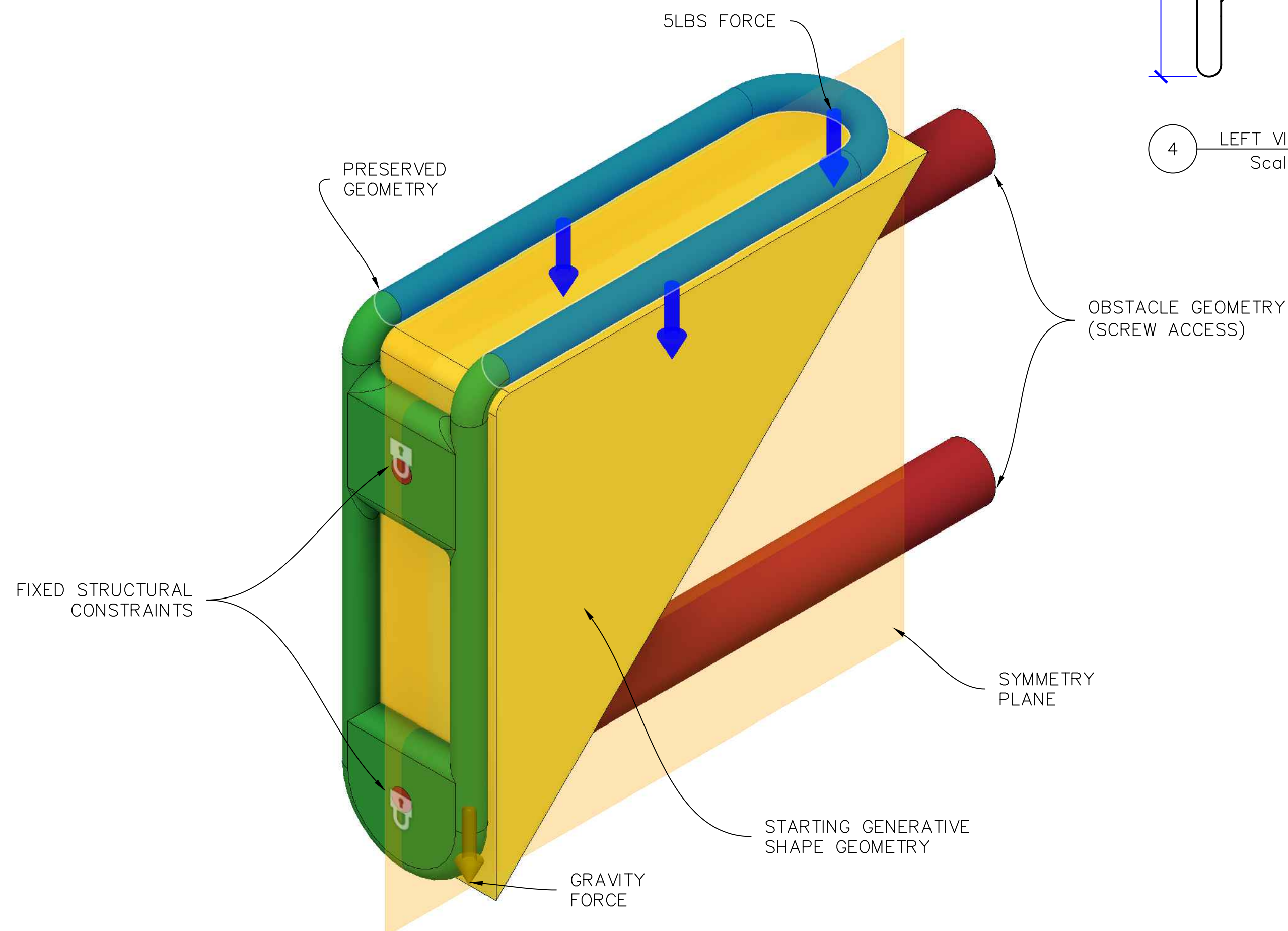

2 GENERATIVE DESIGN DETAILS
Scale: NTS

HARDWARE/FASTNER SCHEDULE	
ID	DESCRIPTION
H-1	BLACK #8 DRYWALL SCREW, 2" L

MATERIALS SCHEDULE	
ID	DESCRIPTION
M-1	GREY SLS POWDER

GENERAL NOTES

BRACKET - 3D PRINT

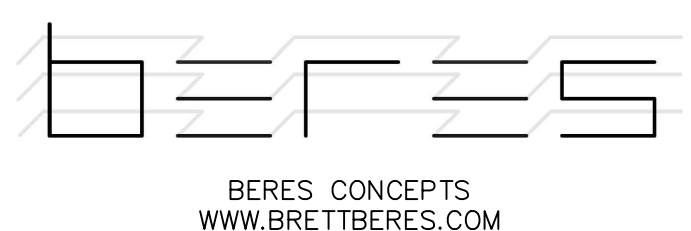

DESCRIPTION:
GENERATIVE SHELF BRACKET

DATE: 04/24/2024	DRAWN BY: B. BERES
SCALE: SCALE AS NOTED	SHEET: 1 OF 1